



BEC 9800VN

GigaConnect[®]

**Wireless-N VoIP Active Ethernet
Point-to-Point Fiber Gateway**

Quick Start Guide



PLEASE READ THE QUICK START GUIDE AND FOLLOW THE STEPS CAREFULLY. THIS QUICK START GUIDE WILL HELP YOU INSTALL THE DEVICE PROPERLY AND AVOID IMPROPER USAGE. IF YOU NEED MORE INFORMATION ON THIS SOFTWARE CONFIGURATION, PLEASE REFER TO THE USER MANUAL ON CD-ROM.

Package Contents

- ✓ BEC 9800VN Wireless-N VoIP Active Ethernet Fiber Gateway
- ✓ This Quick Start Guide
- ✓ CD containing the user manual
- ✓ RJ-45 Ethernet cable
- ✓ Two detachable antennas
- ✓ Power adapter

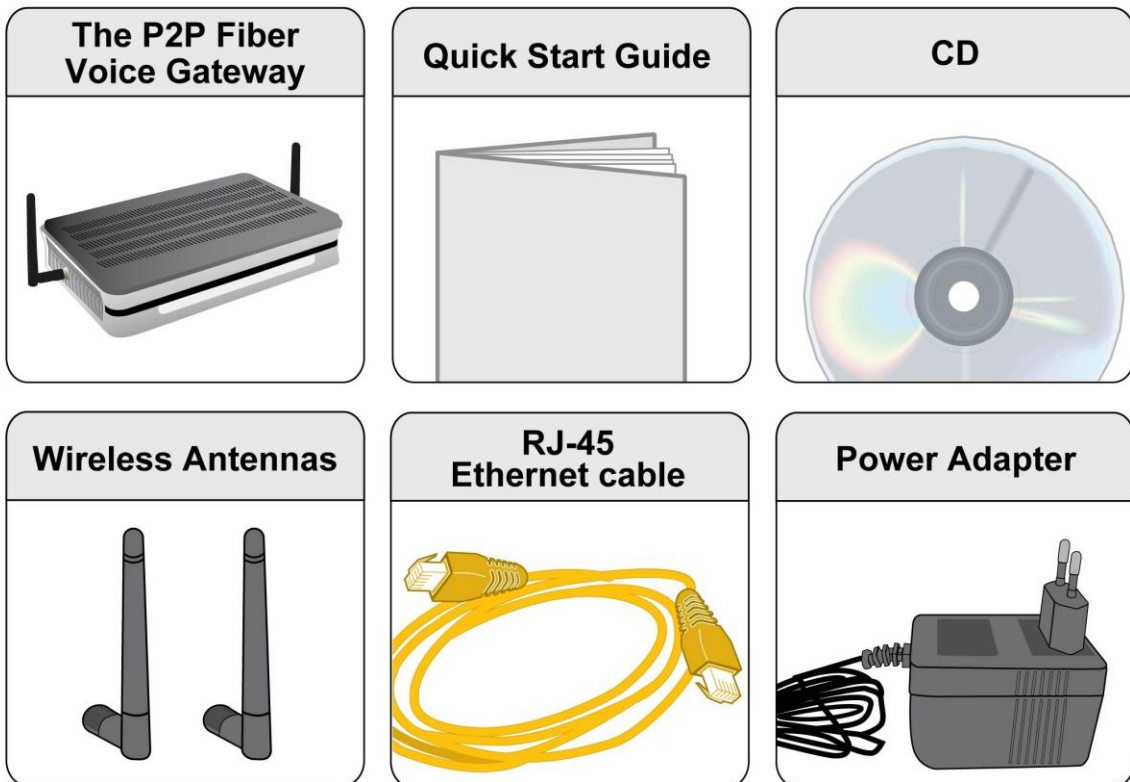

Warning



Attention

- Do not use the router in high humidity or high temperatures.
- Do not use the same power source for the router as other equipment.
- Do not open or repair the case yourself. If the router is too hot, turn off the power immediately and have it repaired at a qualified service center.
- Avoid using this product and all accessories outdoors.
- Place the router on a stable surface.
- Only use the power adapter that comes with the package. Using a different voltage rating power adaptor may damage the router.

Front Panel LEDs

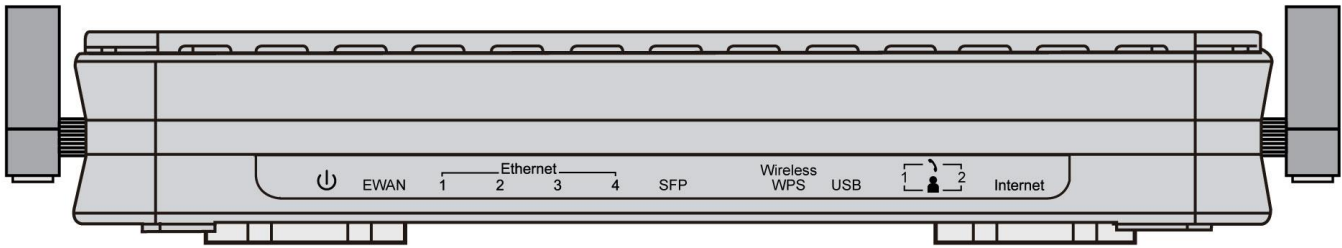

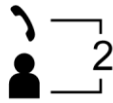
LED	STATUS	DESCRIPTION
Power 	Green	System is up and ready
	Red	Boot failure
EWAN	Lit up	BEC 9800VN is successfully connected with a broadband connection device.
	Green	Transmission speed is at Gigabit speed (1000Mbps)
	Orange	Transmission speed is at 10/100Mbps
	Blinking	Data being transmitted/received
Ethernet Port 1-4	Green	Transmission speed is at Gigabit speed (1000Mbps)
	Orange	Transmission speed is at 10/100Mbps
	Blinking	Data being transmitted/received
SFP	Green	SFP fiber connection is ready.
Wireless/WPS	Green	Wireless connection established
	Green blinking	Data being transmitted / received
	Orange	WPS configuration is in progress
USB	Green	Connecting to a USB dongle or a hard drive.
Phone 1 & 2 	Green	Successfully registered and ready to be used.
	Orange	Phone is off-hook, in-use
Internet	Green	IP connected and traffic is passing thru the device.
	Red	IP request failed.
	Off	BEC 9800VN is either in bridged mode or WAN connection not ready.

Rear Panel Connectors

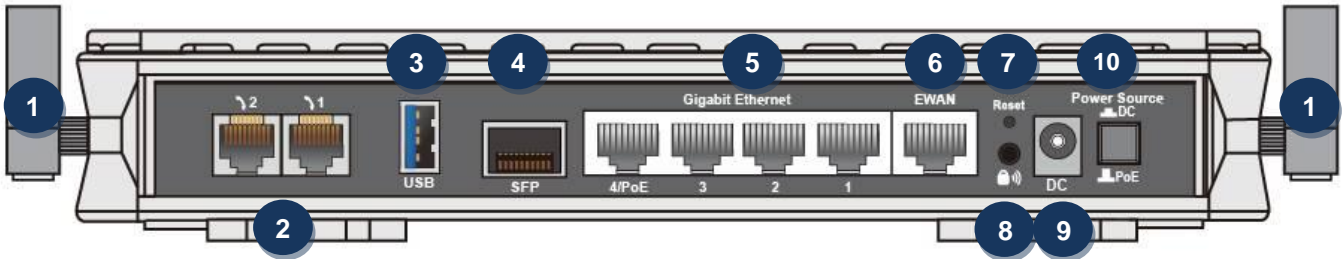

PORT		MEANING
1	Antenna	Screw the supplied Wi-Fi antennas onto the antenna connectors on both sides.
2	Phone (1~2)	Connect your analog phone to the phone port with a RJ-11 cable.
3	USB	Connect an external USB dongle / hard drive for storage, network sharing, etc
4	SFP Cage	Insert and gently push the SFP module until it snap into the slot tightly. Auto-sensing SFP (Small Form Factor Pluggable) transceivers 100Base or 1000Base
5	Gigabit LAN Ethernet (1 ~ 4)	Connect a UTP Ethernet cable (Cat-5 or Cat-5e) to one of the four LAN ports when connecting to a PC or an office/home network of 10Mbps /100Mbps /1000Mbps
	4/PoE	LAN Port 4 is also featuring 802.3at PoE PD (Power over Ethernet)
6	Gigabit EWAN	Connect to Fiber/ Cable/ xDSL Modem with a RJ-45 cable
7	Reset	After the device is powered on, press it 6 seconds or above : to restore to factory default settings (this is used when you cannot login to the router, e.g. forgot your password)
8	WPS & Wireless On/Off	By controlling the pressing time, users can achieve two different effects: (1) WPS ^{*1} : Press &hold the button for less than 6 seconds to trigger WPS function. (2) Wireless ON/OFF button : Press & hold the button for more than 6 seconds to On/Off the wireless.
9	Power	Connect the supplied Power Adapter to this port.
10	Power Source	Power ON/OFF switch (1) with Power Switch ON : power up by the supplied DC power adaptor. (2) with Power Switch OFF : power up by a PoE

* Note: 1. For WPS configuration, please refer to the WPS section in the User Manual.

Hardware Connection

SFP (direct connection to fiber) Mode

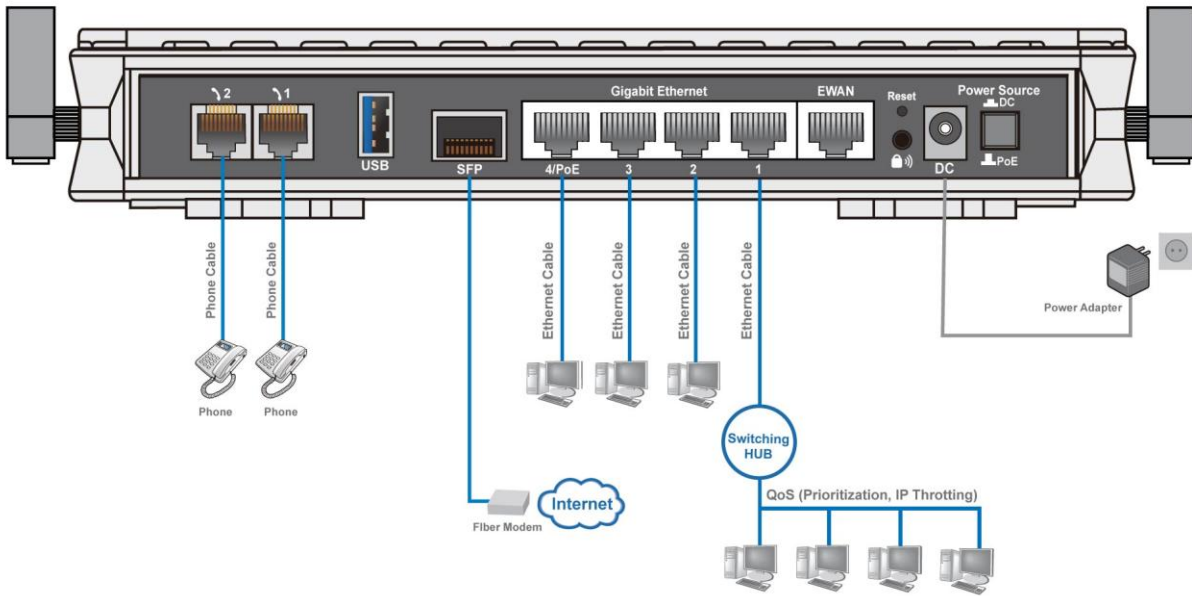

Broadband Router Mode

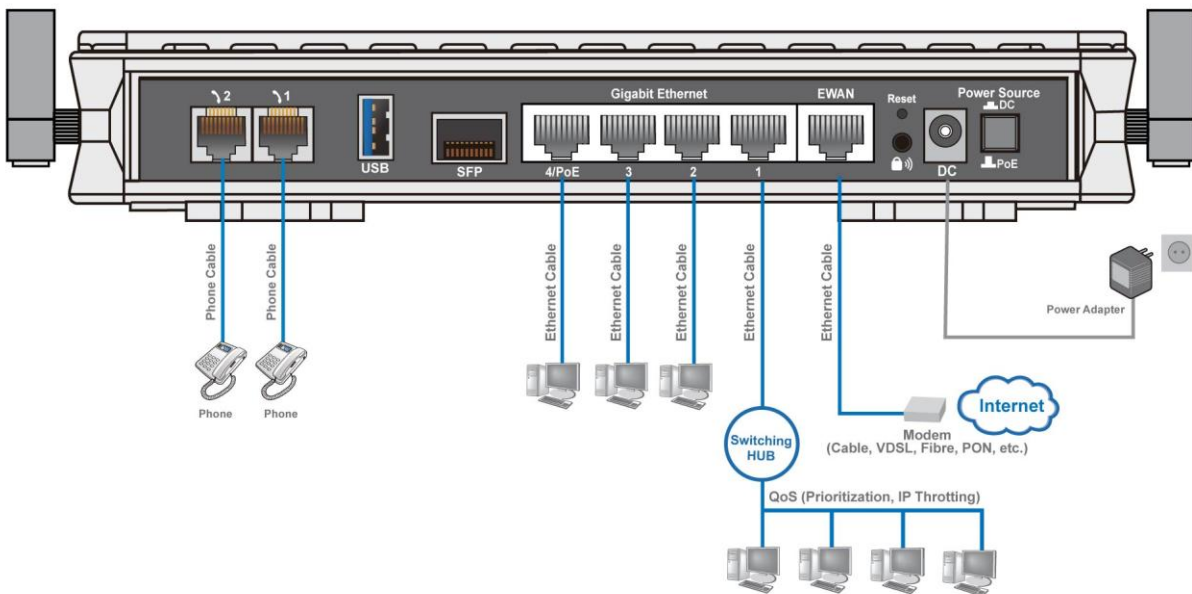

Hardware Installation

1. Power Connection

1.1 Using the DC Power Adaptor

Plug in the supplied power adaptor to the wall jack, the other side to the 9800VN then power **ON** the 9800VN by pressing the Power On/Off button.



1.2 Using a PoE Injector

Connect a RJ-45 Ethernet cable to **LAN Port 4** (known as the **PoE port**) and the other side to a PoE injector then power **OFF** the 9800VN.

IMPORTANT: The PoE Injector / device MUST comply with IEEE802.at standard. Using an 802.af standard PoE device will reduce the performance of BEC 9800VN.



2. LAN Connection

Connect the supplied RJ-45 Ethernet cable to one of the Ethernet ports, and the other side to the PC's Ethernet interface.

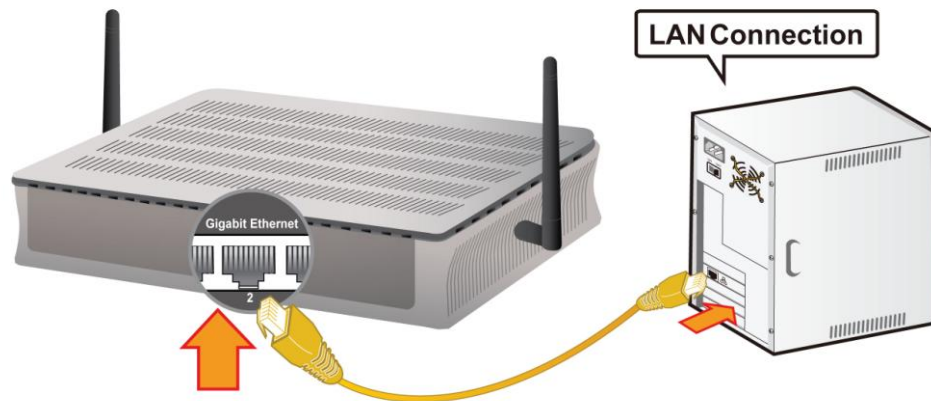

3. WAN Connection

3.1 SFP Interface

Insert then gently push the Mini-GBIC SFP module into the **SFP cage** until it is tightly locked to the cage, and then connect the fiber cable to the module.

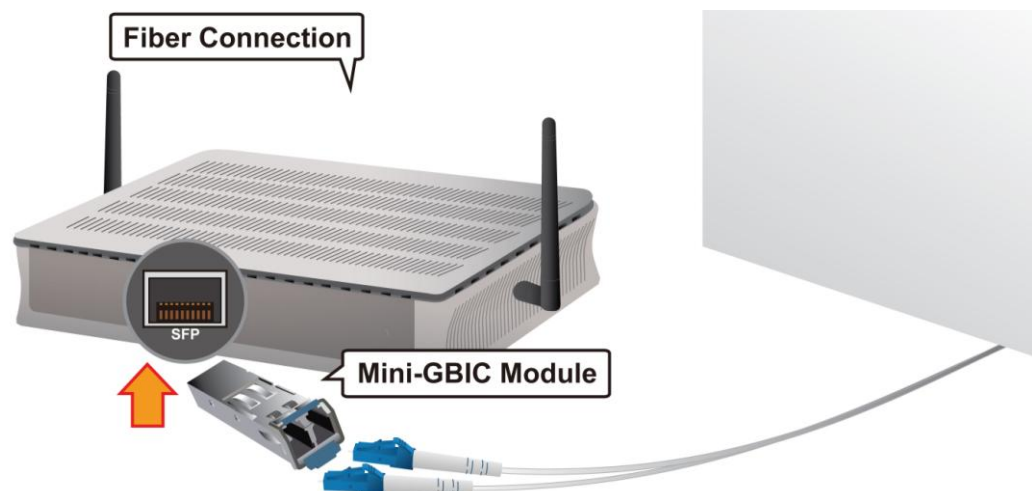

3.2 EWAN Interface

Connect RJ-45 Ethernet cable to the **EWAN port**, and connect the other side to another alternative broadband device, such as Cable Modem, VDSL, Fiber Modem or PON optic lines. **<Please refer to User Manual for detailed instruction.>**

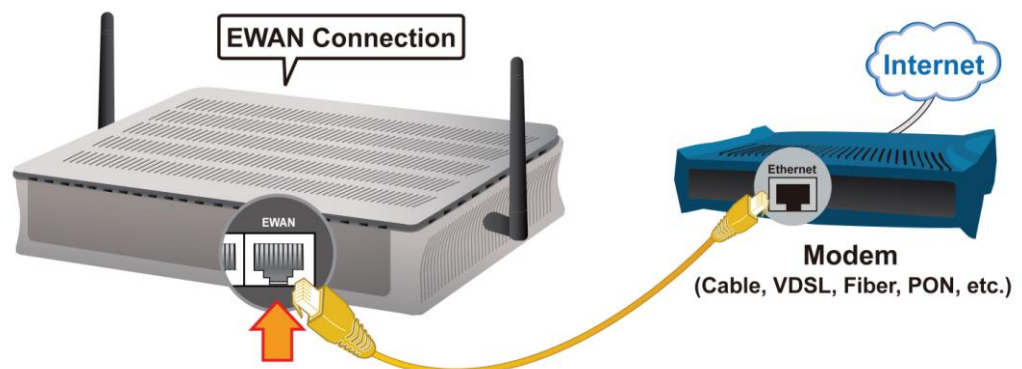

4. Phone Connection

Connect RJ-11 cable to the router's "Phone_1" or "Phone_2" when connecting to an analog phone set. Both ports ("Phone_1" and "Phone_2") can make VoIP calls simultaneously..

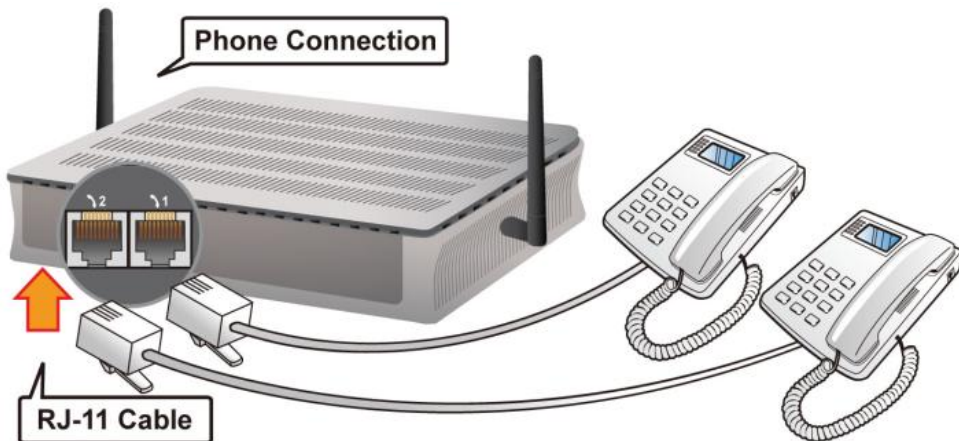

5. USB Connection

FTP or Samba Server attached to the USB port. Simply plug in an external USB HD and do a setup in the GUI. <Please refer to User Manual for detailed instruction.>

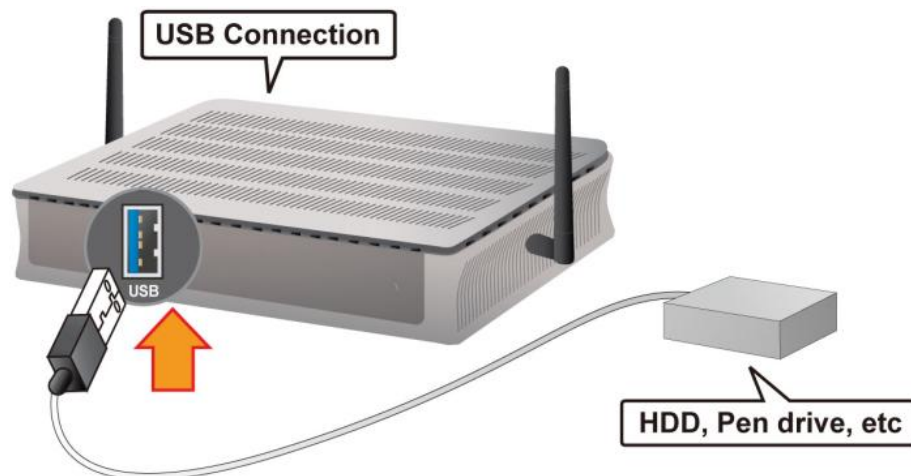

Connecting to the Router

The default IP of modem is **192.168.1.254** with subnet 255.255.255.0. Make sure the attached PC to this router is in the same subnet and has an IP address in the range between 192.168.1.1 ~ 192.168.1.253.

Open a web browser and type **http://192.168.1.254** in the URL address bar.

URL Address bar: type
http://192.168.1.254

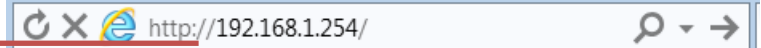

The login prompt will appear. Input the default username (**admin**) and password (**admin**) for Account type, Administrator. *This username / password may vary by different Internet Service Providers.

Quick Setup Your Router

Before start configuring the 9800VN, make sure you have the WAN port connected with your Internet box or fiber line.

Step 1: Change administration password

Setup a new password for “admin” account for device management. The default password is “admin”. Click Continue to go on to the next step.

***The password may vary by different Internet Service Providers.**

New Password: assign a new, **unique password**

Confirm Password: re-enter the new password again

Next Step: click **Next**

Step 2: Time Zone configuration

Enable and select your Time Zone then click Continue to go on to the next step.

Time Zone: select your **time zone**

Next Step: click **Next**

Step 3: Setup Wireless Connection

Access Point: select **Activated**

SSID: Assign an **unique name**

Channel: pick from **1~11**

Security Type: select a mode

- **Disable (No security)**
- **WPA**
- **WPA2 (Most secure one)**
- **WPA / WPA2 (auto detect WPA mode with wireless clients)**
- **WEP (Less secure one)**

Pre-Shared Key: key for wireless authentication

- **WPA / WPA2 Share Key:** Assign a key between 8 ~ 63 characters.
- **WEP:** select **Open System**, use default WEP Key 1 then assign **26 Hex codes**

Next Step: click **Next**

Step 4: WAN / Internet Connection Setup

Select the appropriate WAN protocol then fill out the information provided by your ISP in all relevant parameters.

Protocol: select one of them

- **Dynamic IP Address** (Obtain an IP automatically)
- **Static IP Address** (Manually assign an IP)
- **PPPoE**
- **Bridge Mode**

Net Step: click **Continue**

Step 5: Save Confirmation Settings

Click “Next” to save and complete the Quick Setup. You should now be able to access to the Internet.

Please see the relevant sections of User Manual for detailed information.

Troubleshooting

1. **None of the LEDs are on when you turn on the router.**
Check the connection between the adapter and the router. If the error persists, you may have a hardware problem. In this case you should contact technical support.
2. **You have forgotten your router login and/or password.**

Try the default login and password, please refer to User Manual. If this fails, you can restore your router to its factory settings by holding the Reset button on the back of your router for 6 seconds or more.

3. Can't ping any PCs on the LAN.

Check the Ethernet LEDs on the front panel. The LED should be on for a port that has a PC connected. If it is off, check the cables between your router and the PC. Make sure you have uninstalled any software firewall for troubleshooting. Verify that the IP address and the subnet mask are consistent between the router and the workstations.

Product Support and Contact Information

Most problems can be solved by referring to the **Troubleshooting** section in the User Manual. If you have other inquiries or need further technical support, please contact with your Internet Service Provider or visit us at www.bectechnologies.net.